

INSTALLATION GUIDE

METAL PEGBOARD



SCAN THIS QR CODE FOR
THE FULL INSTALL VIDEO.

Questions or Concerns?

Contact us at:  info@storeyourboard.com

IMPORTANT INFORMATION

Metal Pegboard

Manufactured for Spire LLC in Vietnam

Quantity: 1

WARNING! The product is NOT intended for use by any person under the age of 18 years old. You must be over the age of 18 to install or use the product.

WARNING! Strictly follow all instructions to avoid an accident, damage to property, personal injury or death.

READ THE ENTIRE USER MANUAL BEFORE INSTALLATION

The User Manual you received with your product provides instructions on how to install and use your product. The instructions are written for a person with a basic understanding of tools and procedures. Read the entire manual before proceeding. If you do not understand any portion of the instructions, do not attempt installation, and email us with the information on the cover.

CORRECTLY INSTALL THE PRODUCT

Read and follow all instructions carefully.

Failure to properly install and use the product could allow the product to dismantle or fall, injuring persons or personal property in the process. Accordingly, it is critical that the product be assembled and installed correctly and according to the instructions in the User Manual.

USE TOOLS SAFELY

The procedures in the User Manual may require climbing ladders and/or operating power tools. Make sure you are familiar with these tools and their safety procedures before attempting to use such tools during installation. Always be aware of electrical wires during installation. Failure to do so could result in an electrical shock or death.

CAUTION

It is the consumer's responsibility to install this system in accordance with all codes, ordinances, and local regulations.

When installing the product, it is the consumer's responsibility to ensure the structural integrity of the structure it is being mounted to.

The product is intended for the storage of sporting equipment only. Do not use it for any other purpose.

This system has a maximum capacity stated in the following section. Overloading the system could result in damage to property or injury.

Use extreme caution when loading and unloading equipment from this system.

It is the consumer's responsibility to ensure that the system is in proper working condition before loading objects onto the system. Check tightness of all bolts and screws periodically. Failure to properly maintain the system could result in damage to property or injury.

WARNING AND DISCLAIMER

Spire LLC (d/b/a StoreYourBoard) expressly disclaims any and all liability for personal injury, property damage or loss, whether direct, indirect, incidental, resulting from the incorrect mounting, improper use, inadequate maintenance, or neglect of this system.

METAL PEGBOARD PARTS

WEIGHT LIMITS:

150 lbs. per panel when evenly distributed and properly installed in wood wall studs

REQUIRED TOOLS:

Drill/driver
Stud Finder
1/8" (3mm) drill bit
Phillips Screw driver
Level

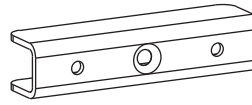
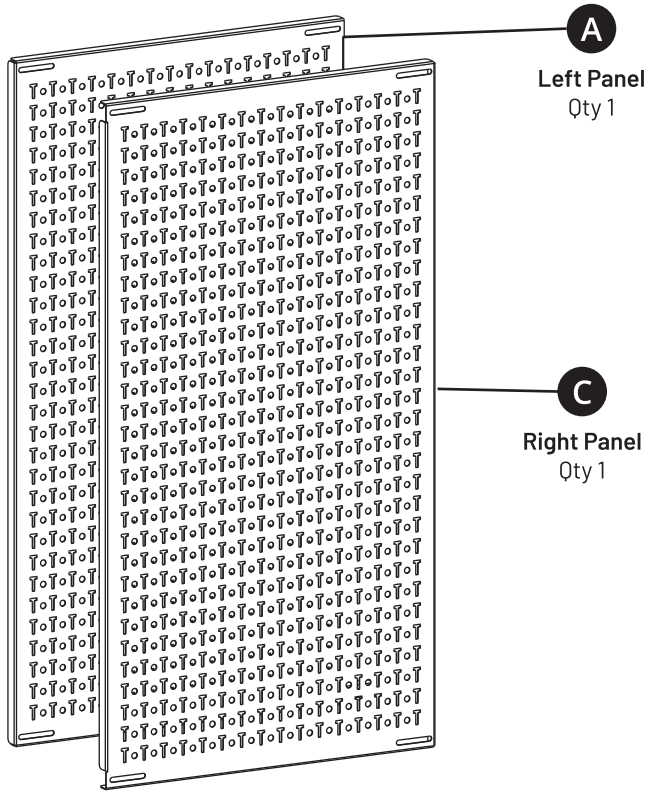

D
Connector Bracket
Qty 2



E
Corner Bushing
Qty 4

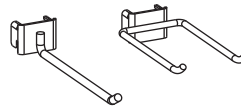

I
Attachments
Qty Varies

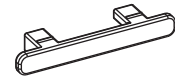

J
Plastic Lock Clip
Qty 1 per attachment



F
Small Screw
M5 x 10mm Pan Head
Qty 4



G
Corner Screw
M5 x 50mm Flange Head
Qty 4



H
Connector Screw
M6 x 60mm Flat Head
Qty 2

INSTALLATION OVERVIEW

1. Locate and Mark the Studs
2. Mark the Bracket Points
3. Pre-drill the Holes
4. Install the Connector Brackets
5. Install the Side Panels
6. Install the Top Corner Screws
7. Prepare for Bottom Bracket Installation
8. Install the Bottom Connector Brackets
9. Connect the Panels
10. Drill the Bottom Corner Pilot Holes
11. Install the Bottom Corner Screws
12. Finalize the Panel Arrangement
13. Install the Attachments

INSTALLATION AIDS

This is a fully installed system *viewed from the back* so you can see where the brackets and screws will go between the wall and the pegboard panels. It only shows the top brackets, the bottom brackets are the same.

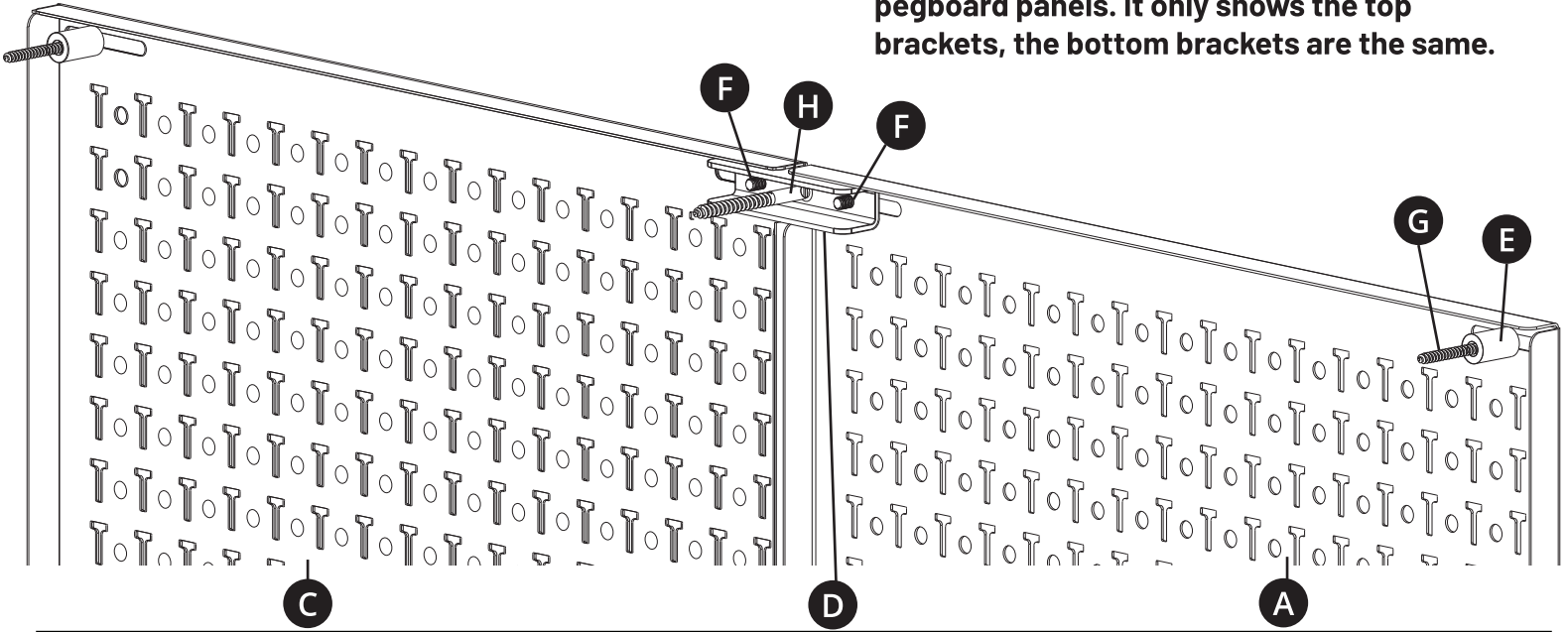

HOW TO IDENTIFY PANELS

These are panels *viewed from the back* to show the cutouts to help identify left, middle, and right. Left and Right are in reference to the front when facing upright.

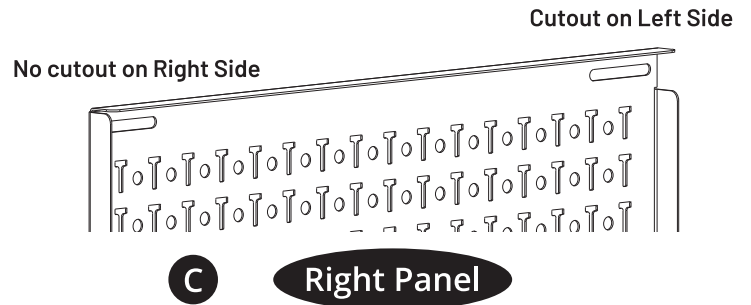
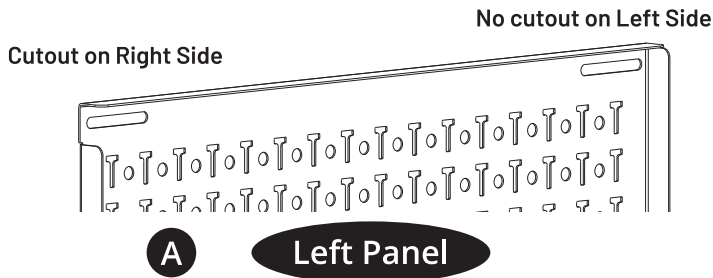

NOTE: The following images show the pegboard being installed with exposed studs for visual demonstration only. The same steps work for all wall coverings like drywall, plywood, OSB, paneling, etc.

INSTALLATION STEPS

1 Locate and Mark the Studs

Use a stud finder to identify the center of the studs where you plan to mount the pegboard panels. Mark these points for reference.

2 Mark the Bracket Points

With a pencil, a level, and a straight edge (like a long level or the edge of a cardboard box), mark the points where the upper brackets will attach to the studs. Mark the intersection of a level line along the center of 3 adjacent studs. This line will be approximately $\frac{1}{2}$ " below the top edge of the installed location of the panels.

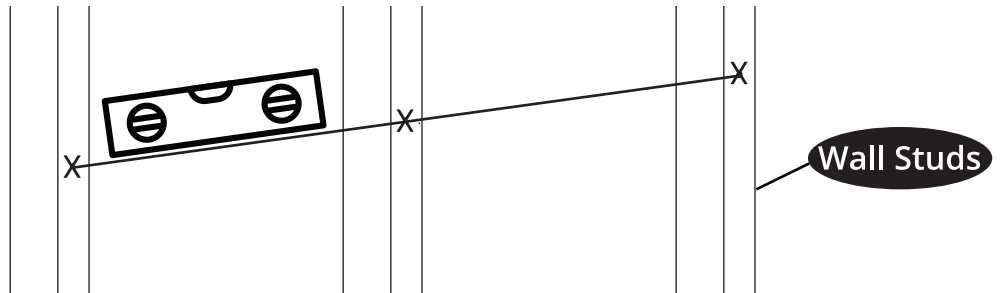

3 Pre-drill the Holes: Using a 1/8" drill bit, pre-drill the 3 marked holes.

4 Install the Connector Brackets

With a Phillips head screwdriver and a Connector Screw (H), install the Connector Bracket (D) into the middle hole you just drilled. Leave the corner holes empty for now.

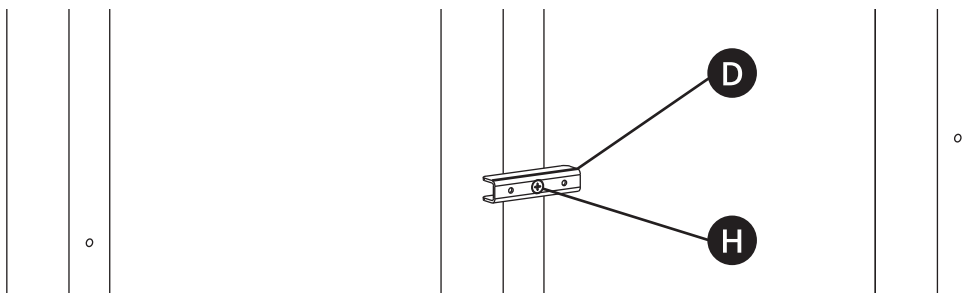

5 Attach the Panels

Mount the Left and Right Panels (A and C) onto the Connector Bracket (D) using Small Screws (F). Do not fully tighten the screws yet. Make sure the panel is facing the right direction as shown, the cutouts should look like a capital T

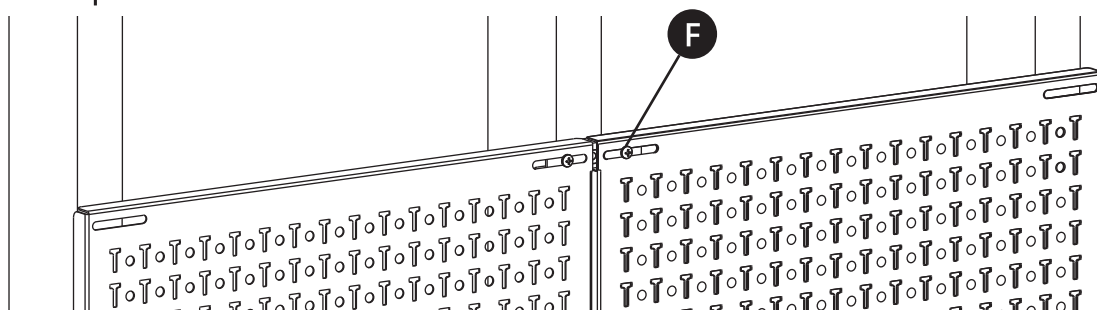

6 Install the Top Corner Screws

Position a Corner Bushing (E) behind the Left and Right Panels (A and C). Insert the Corner Screw (G) through the front of the panel slot and into the hole you drilled. Keep these screws about 2 full turns away from being fully tightened.

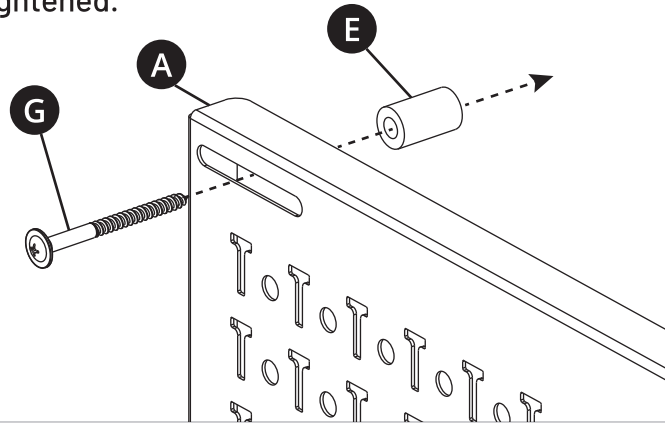

7 Prepare for Bottom Bracket Installation

Adjust the panels so that the lower slot on one panel covers the middle stud. Ensure alignment with the stud and use a 1/8" drill bit through the slot to create a pilot hole for the bottom connector brackets.

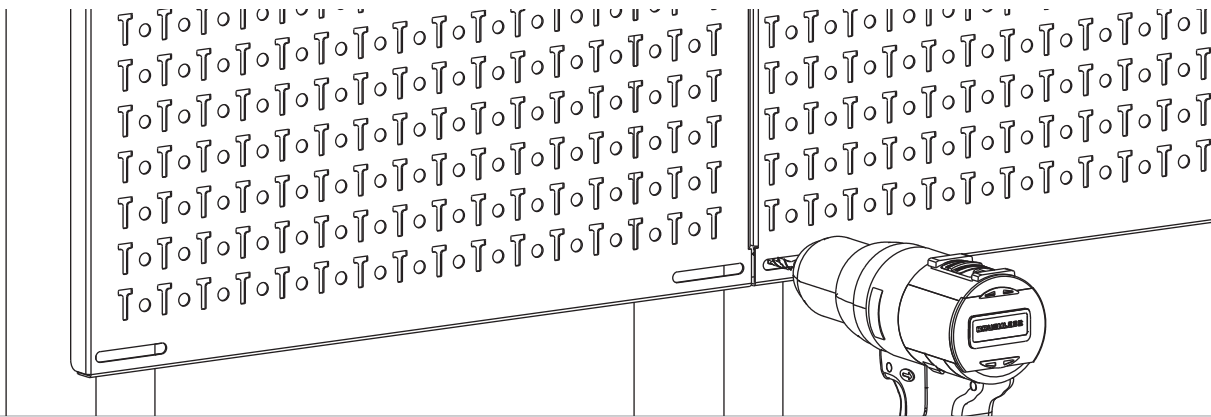

8 Install the Bottom Connector Brackets

Adjust the panels again to position the bottom Connector Bracket (D) behind the panels. The mounting hole should be exposed over the pilot hole you just drilled. Install the bracket with a Connector Screw (H).

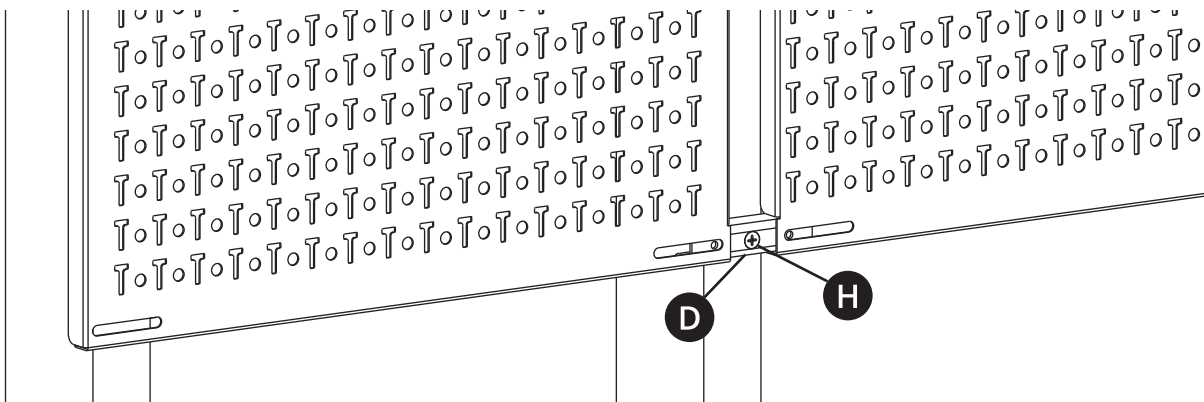

9 Connect the Panels

Attach the panels to the bottom Connector Brackets using Small Screws (F). Do not fully tighten the screws.

10 Drill the Bottom Corner Pilot Holes

Arrange all of the panels in their desired positions and use a 1/8" drill bit to create a pilot hole for the 2 bottom corner screws.

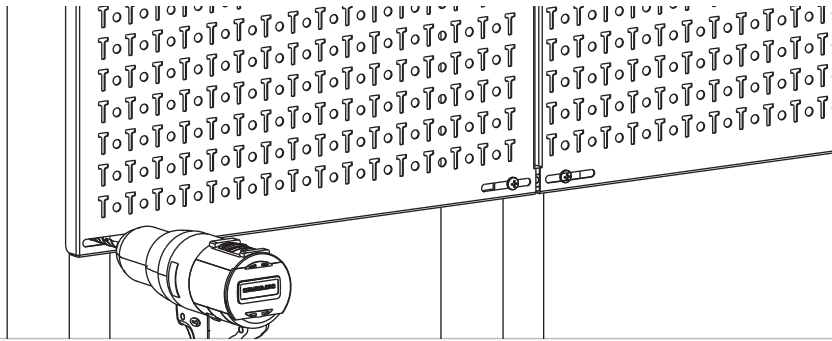

11 Install the Bottom Corner Screws

With all of the screws slightly loose, gently pull the Left and Right Panels (A and C) away from the wall to position the Corner Bushings (E) behind the panel. Attach them using the Corner Screw (G) to the bottom corner pilot holes you just drilled.

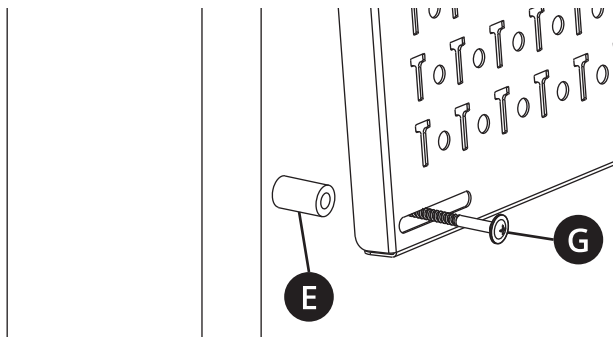

12 Finalize the Panels: Arrange all panels in their final positions and fully tighten all of the screws.

13 Install the Attachments

Insert Attachments (I) into the T-slots by aligning the tabs with the corner cutouts in the pegboard and sliding down. To prevent the attachments from moving or accidentally coming out when removing a tool, place Plastic Lock Clips (J) into the space above the attachment. To remove them, gently pry one edge of the plastic lock clips with your finger or a flathead screwdriver.

