

▲ TEAL TRIANGLE

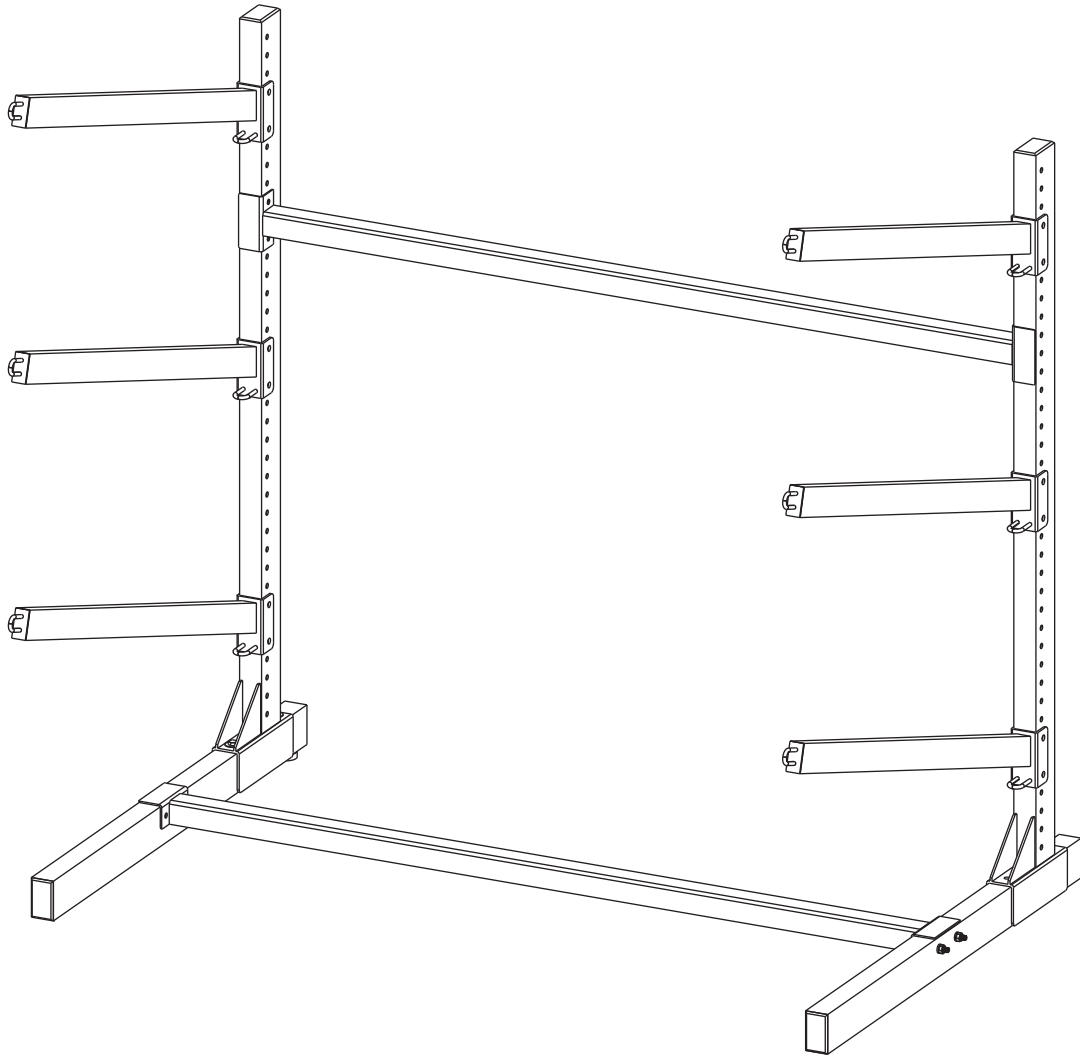

INSTALLATION GUIDE

G-SYSTEM FREESTANDING



SCAN THIS QR CODE FOR
THE FULL INSTALL VIDEO.

Questions or Concerns?

Contact us at:  support@tealtriangle.com

IMPORTANT INFORMATION

3 Slot Freestanding G-System Rack

Manufactured for Spire LLC in Vietnam

Quantity: 1

WARNING! The Freestanding G-System Rack is NOT intended for use by any person under the age of 18 years old. You must be over the age of 18 to install or use the Freestanding G-System Rack.

WARNING! Strictly follow all instructions to avoid an accident, damage to property, personal injury or death.

WARNING! Do not use this product for human suspension. Components can fail causing person to fall, possibly resulting in serious injury or death.

WARNING! When operating system, make sure the area below object is clear of persons. If object comes down too quickly, this can cause an accident.

READ THE ENTIRE USER MANUAL BEFORE INSTALLATION

The User Manual you received with your Freestanding G-System Rack provides instructions on how to install and use your Freestanding G-System Rack. The instructions are written for a person with a basic understanding of tools and procedures. Read the entire manual before proceeding. If you do not understand any portion of the instructions, do not attempt installation, and email support@tealtriangle.com.

CORRECTLY INSTALL THE PRODUCT

Read and follow all instructions carefully.

Failure to properly install and use the Freestanding G-System Rack could allow the product to dismantle or tip over, injuring persons or personal property in the process. Accordingly, it is critical that the Freestanding G-System Rack be installed correctly and according to the instructions in the User Manual.

USE TOOLS SAFELY

The procedures in the User Manual may require climbing ladders and/or operating power tools. Make sure you are familiar with these tools and their safety procedures before attempting to use such tools during installation. Always be aware of electrical wires during installation. Failure to do so could result in an electrical shock or death.

CAUTION

It is the consumer's responsibility to install this system in accordance with all codes, ordinances, and local regulations.

When installing the Freestanding G-System Rack, it is the consumer's responsibility to ensure the structural integrity of the structure it is being mounted to.

The Freestanding G-System Rack is intended for the storage of sporting equipment only. Do not use it for any other purpose.

This system has a maximum capacity of 300 lbs. Overloading the system could result in damage to property or injury.

Use extreme caution when loading and unloading equipment from this system.

It is the consumer's responsibility to ensure that the system is in proper working condition before loading objects onto the system. Check tightness of all bolts and screws periodically. Failure to properly maintain the system could result in damage to property or injury.

WARNING AND DISCLAIMER

Spire LLC (d/b/a Teal Triangle) expressly disclaims any and all liability for personal injury, property damage or loss, whether direct, indirect, incidental, resulting from the incorrect mounting, improper use, inadequate maintenance, or neglect of this system.

G-SYSTEM PARTS

REQUIRED TOOLS:

10mm socket
10mm or adjustable wrench

WEIGHT LIMITS:

50 lbs. max per attachment
300 lbs. max total

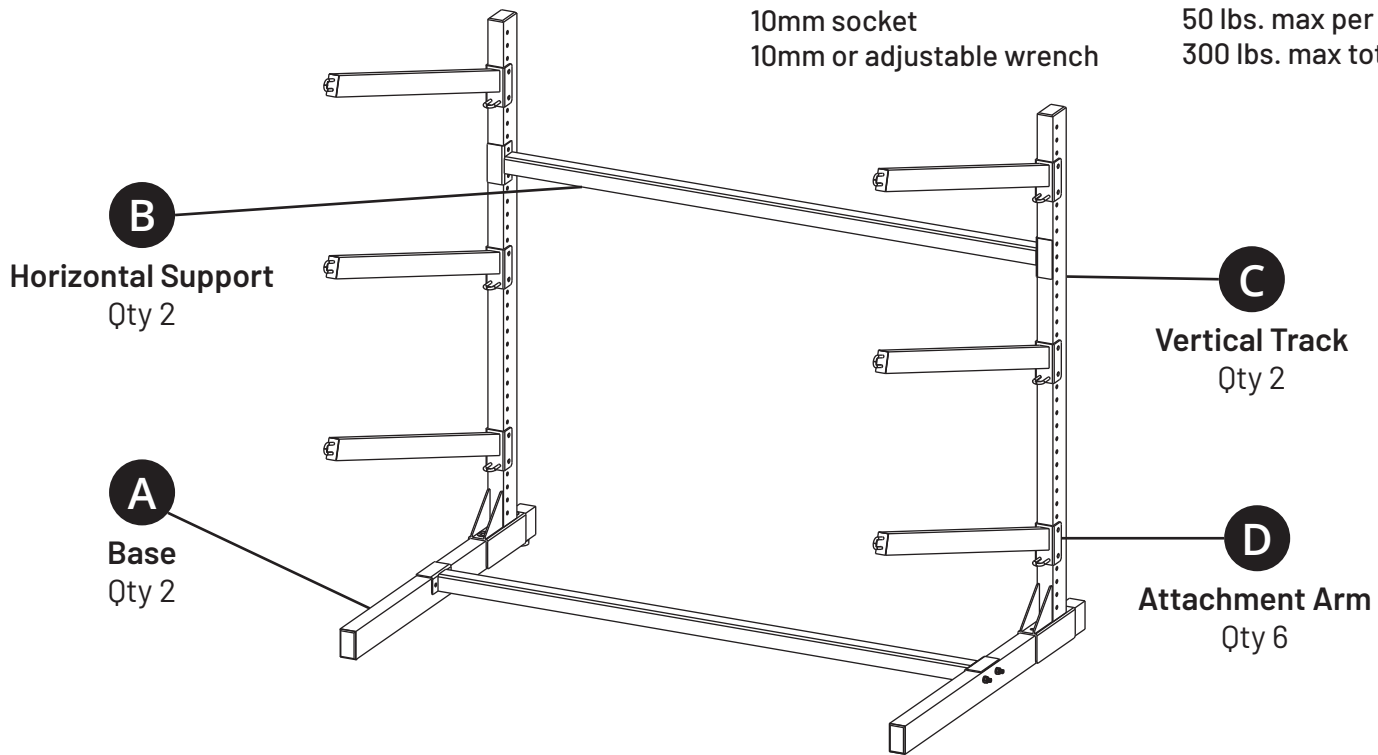

G-SYSTEM HARDWARE

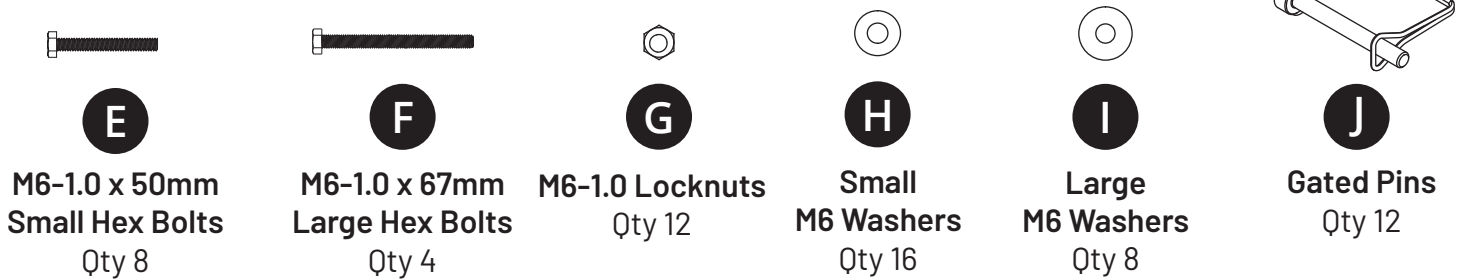

INSTALLATION

1

Use a 10mm socket and wrench to connect one Horizontal Support (B) to the left and right Bases (A). Use 4 Small Hex Bolts (E), 8 Small Washers (H), and 4 Locknuts (G) for this step.

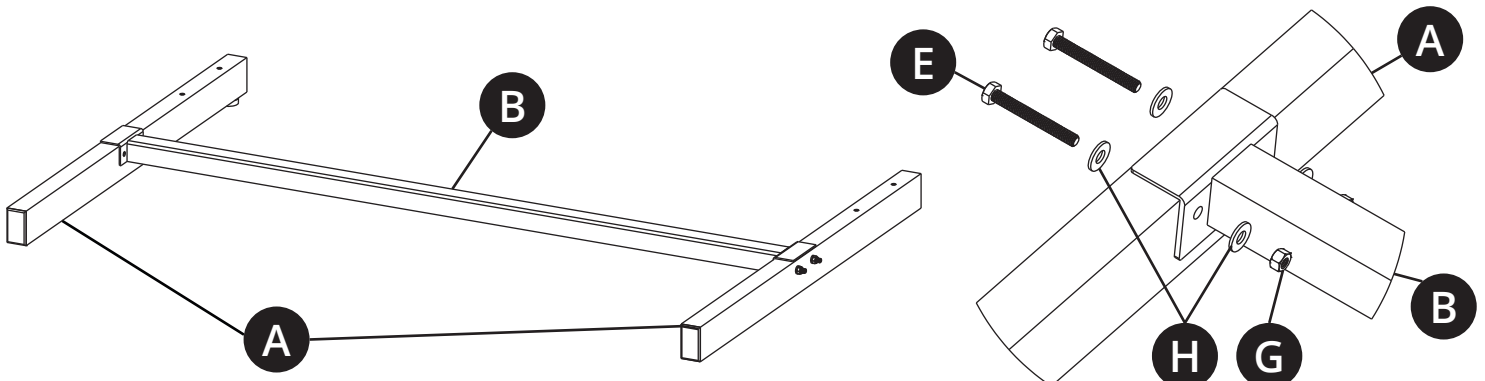

2

Fasten each Vertical Track (C) to the Bases (A). Use 4 Large Hex Bolts (F), 8 Large Washers (I), and 4 Locknuts (G) for this step. Take note of the orientation in the picture.

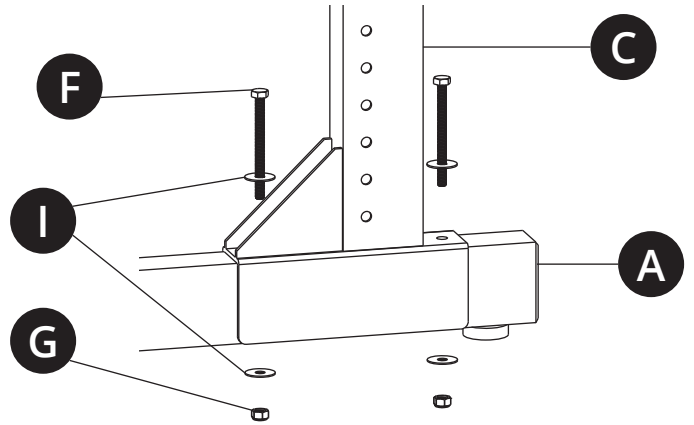
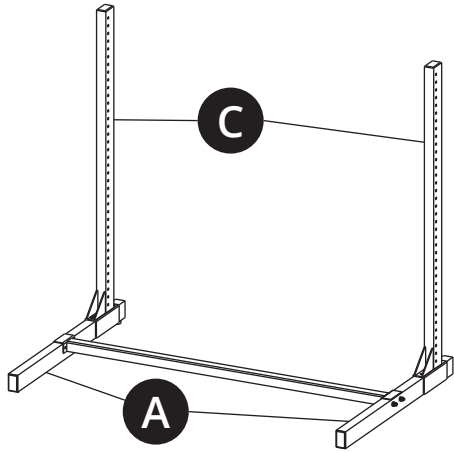

3

Connect one Horizontal Support (B) to the left and right Vertical Tracks (C) - the same way you did in Step 1. Use 4 Small Hex Bolts (E), 8 Small Washers (H), and 4 Locknuts (G) for this step.

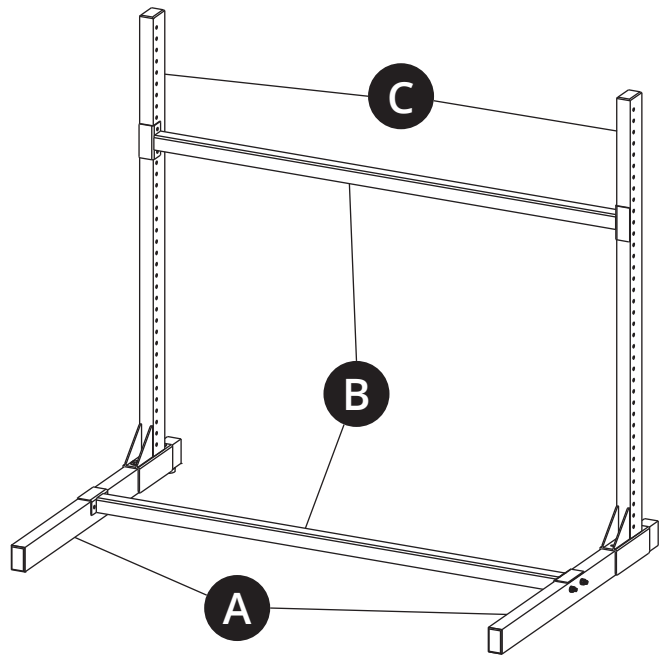

4

Add Attachment Arms (D) at desired locations by aligning the hole on the base with the hole on the Vertical Tracks (C) and insert Gated Pins (J). Gently bend the wire on the gated pin to open and close the locking mechanism.

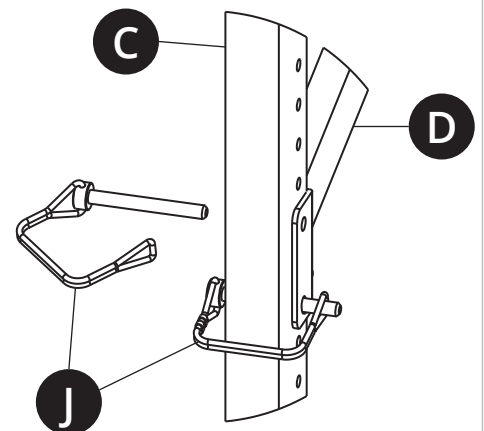
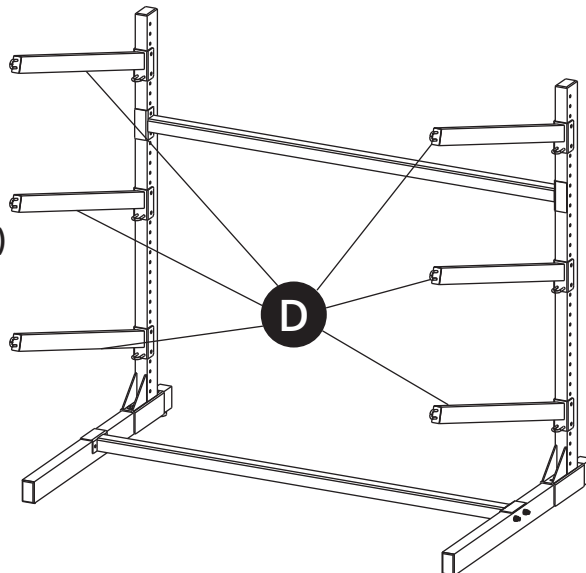

5

If you ordered the optional locking caster wheels, unscrew the leveling feet on the bottom of the Bases and fasten the casters using the supplied 13mm hex wrench.

